



SAW BANDPASS FILTER

PART NO.: ACTFH004-2350SA-1109

Product Type:	Customer:
SAW filter for Band 40	
	Customer Part NO.:
	Issued Date:

Features

SAW filter for Band 40

- 1 High stability and reliability with good performance.
- 2 Narrow and sharp pass band characteristics. RoHS compatible.
- 3 Low insertion loss and deep stop band attenuation for interference.
- 4 Low – loss SAW filter for Band 40.
- 5 Package size 1.1mm*0.9mm

Package Dimensions

Ceramic Package: Unit: mm

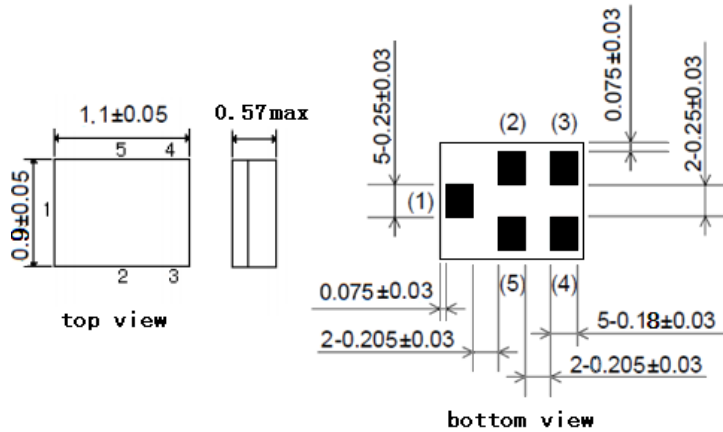

Pin Configuration

1	Input
4	Output
2,3,5	Ground

Marking

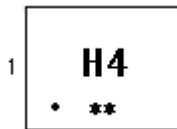

Top View, Laser Marking

"H4": Part number

"1": Terminal1

The first "*": Month Code (The code shown below varies in a 4-year cycle)

Month	1	2	3	4	5	6	7	8	9	10	11	12
2016/2020	n	p	q	r	s	t	u	v	w	x	y	z
2017/2021	A	B	C	D	E	F	G	H	J	K	L	M
2018/2022	N	P	Q	R	S	T	U	V	W	X	Y	Z
2019/2023	a	b	c	d	e	f	g	h	i	j	k	m

The second "*": Date Code

data	1st	2nd	3rd	4th	5th	6th	7th	8th	9th	10th	
code	A	B	C	D	E	F	G	H	J	K	
data	11th	12th	13th	14th	15th	16th	17th	18th	19th	20th	
code	L	M	N	P	Q	R	S	T	U	V	
data	21st	22nd	23rd	24th	25th	26th	27th	28th	29th	30th	31th
code	W	X	Y	Z	a	b	d	e	f	g	h

Maximum Ratings

DC Voltage (between any Terminals)	V_{DC}	10	V
RF Power (in <i>BW</i>)	P	13	dBm
Operating Temperature Range	T_A	-30 ~ +85	°C
Storage Temperature Range	T_{stg}	-40 ~ +85	°C

Electrical Characteristics:

Insertion Loss	IL				
2300 2400 MHz			2.5	3.8	dB
Passband Ripple	Pr				
2300 2400 MHz			1.3	2.6	dB
VSWR	V_{swr}				
2300 2400 MHz			2.2	2.7	
Absolute Attenuation	α				
1559 1563 MHz		30	43		dB
1563 1573 MHz		30	43		dB
1573 1577 MHz		30	43		dB
1577 1585 MHz		30	43		dB
1598 1606 MHz		30	43		dB
4600 4800MHz		25	30		dB
5725 5825 MHz		20	25		dB
6900 7200 MHz		20	25		dB
Input / Output Impedance (Nominal)		50 Ω / 50 Ω ($//2.7nH$)			

 **RoHS Compliant**

 **Electrostatic Sensitive Device**

Typical Frequency Response S21

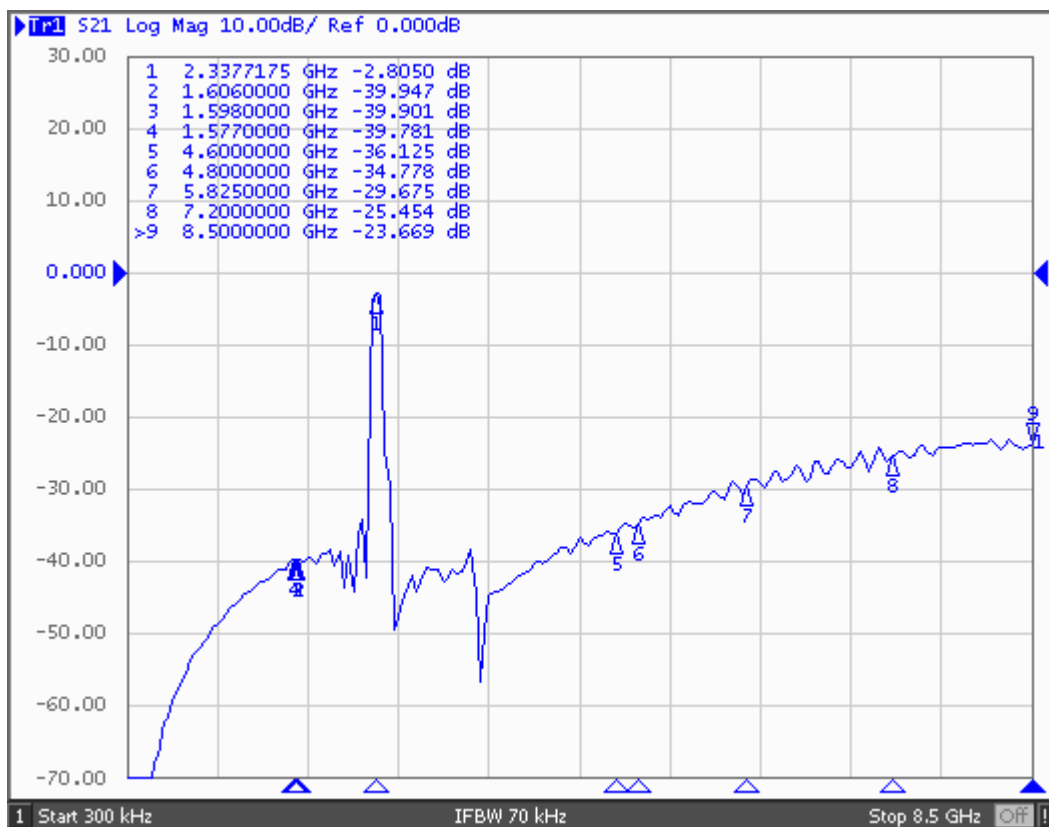
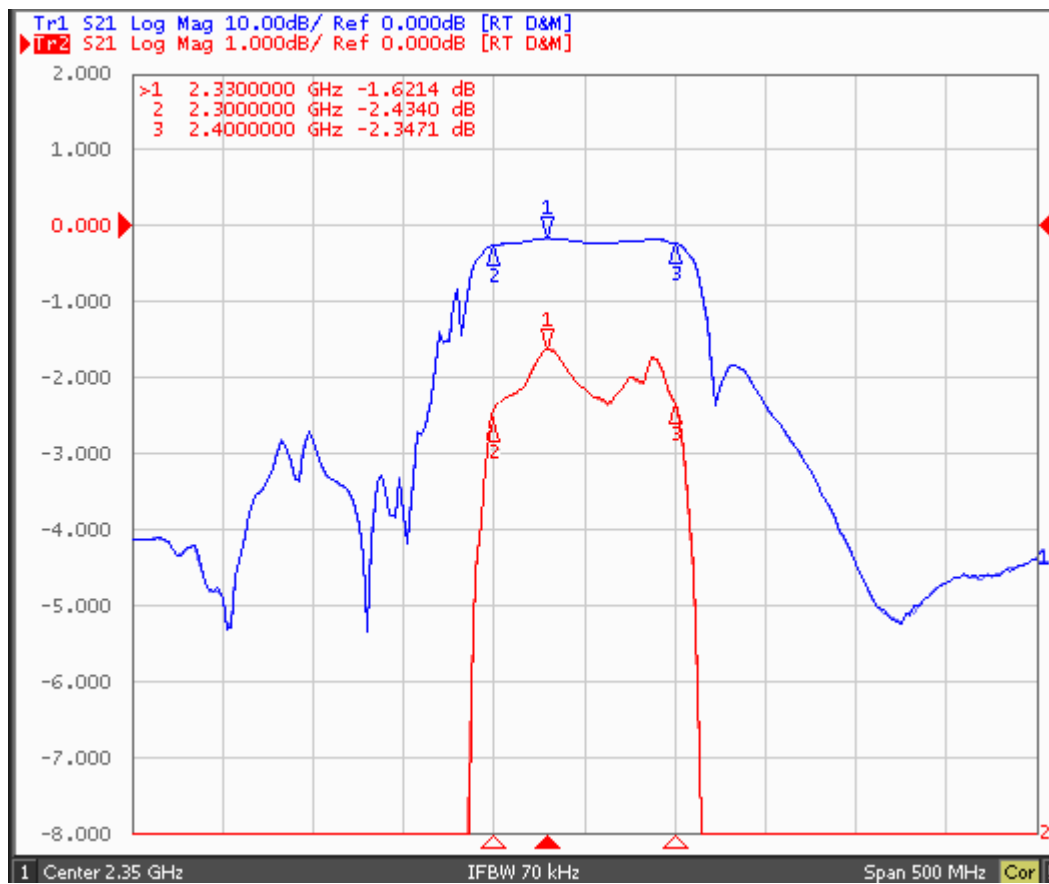



Stability Characteristics

Item No.	Test Item	STD Reference	Test Conditions	per lot
	Preconditioning	JESD22-A113	1) Temperature Cycling, 5 cycles -40°C to 85°C; 2) Bake, 24 hrs @85±5°C; 3)Moisture Soak, Soak time and conditions per IPC/JEDEC J-STD-020 based on device MSL level; 4) Reflow, 3 reflow cycles; 5) Drying, Room ambient temperature.	All behind
1	Temperature Cycling	JESD22-A104	-40°C / +85°C,5°C/min,15min dwell,<1 min transfer time,500cycles	3*25 pcs
2	High Temperature Storage	JESD22-A103	Temperature=85°C, 1000 hours.	3*25 pcs
3	Temperature Humidity no bias	JEDEC Std A101-B	85°C 85%RH 240 hours	3*25 pcs
4	Human Body Mode ESD	JESD22-A114	Ta=25°C, ≥100V	3 pcs
5	Charge Device Mode ESD	JESD22-C101	Ta=25°C, ≥100V	3 pcs
6	Solderability	JESD22-B102	Wetting: 245°C, 5s.	22 pcs
7	Drop Test	JESD22-B111	1500 Gs, 0.5 millisecond duration, half-sine pulse.	20 pcs
8	Mechanical Shock	JESD-47	Shock pulse of 1500g with pulse duration of 0.5+/-0.1msec (X ,Y & Z); 5 shocks per axis.	3*25 pcs

Requirements: The SAW filer shall remain within the electrical specifications after tests.

Packing Information

Carrier Tape

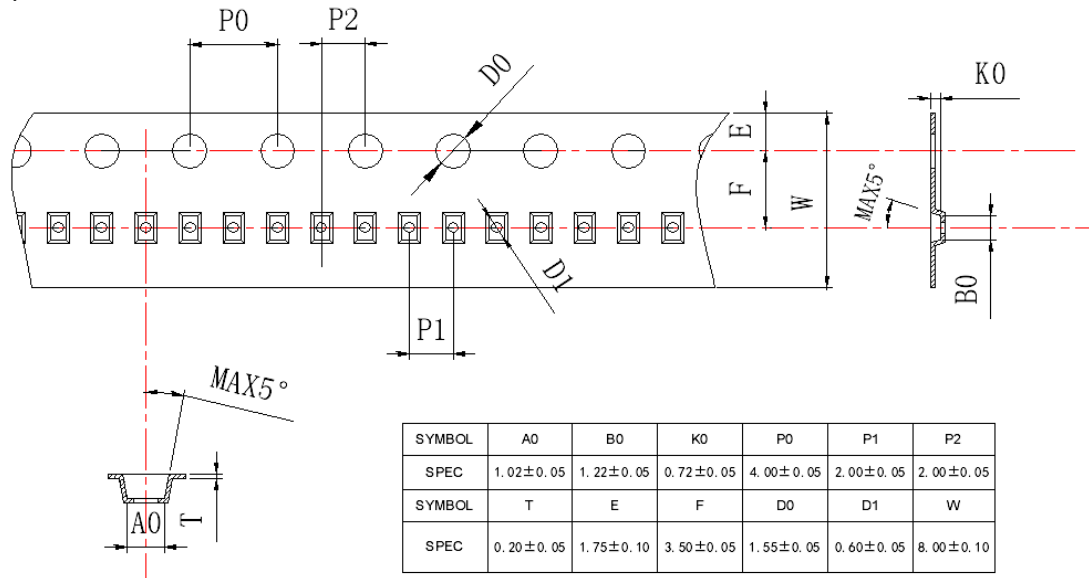

Reel Dimensions

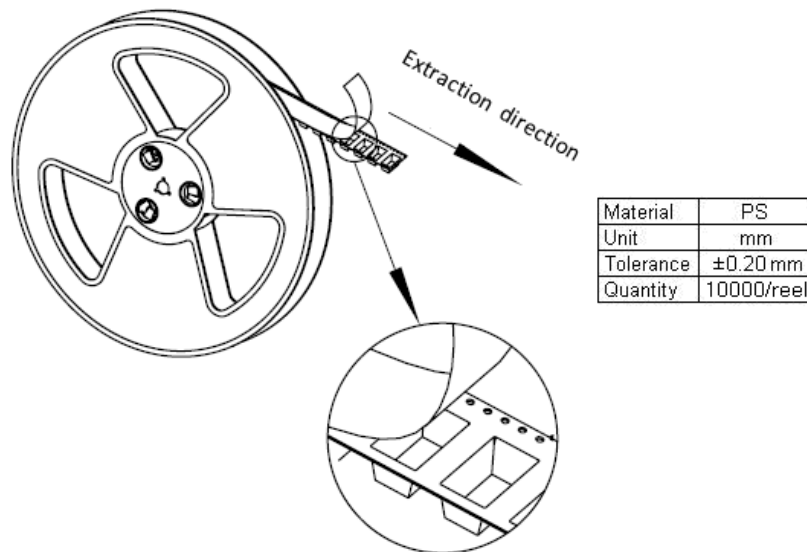

Outer Packing

Carton Box I	100000	240x210x285	anti-static plastic bag & carton box 1 reel / bag	2.15
Carton Box II	300000	470x310x285	10bags / box (100000 pcs) 30 bags / box (300000pcs)	6.22

Unit: mm

Unit: kg

Requirements: The SAW filer shall remain within the electrical specifications after tests.

Remarks

- SAW devices should not be used in any type of fluid such as water, oil, organic solvent, etc.
- Be certain not to apply voltage exceeding the rated voltage of components.
- Do not operate outside the recommended operating temperature range of components.
- Sudden change of temperature shall be avoided, deterioration of the characteristics can occur.
- Be careful of soldering temperature and duration of components when soldering.
- Do not place soldering iron on the body of components.
- Be careful not to subject the terminals or leads of components to excessive force.
- SAW devices are electrostatic sensitive. Please avoid static voltage during operation and storage.
- Ultrasonic cleaning shall be avoided. Ultrasonic vibration may cause destruction of components.

Test Circuit

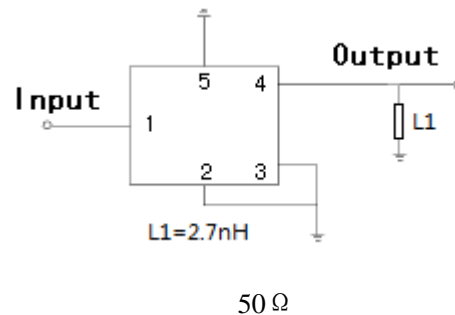

Recommended Soldering Profile

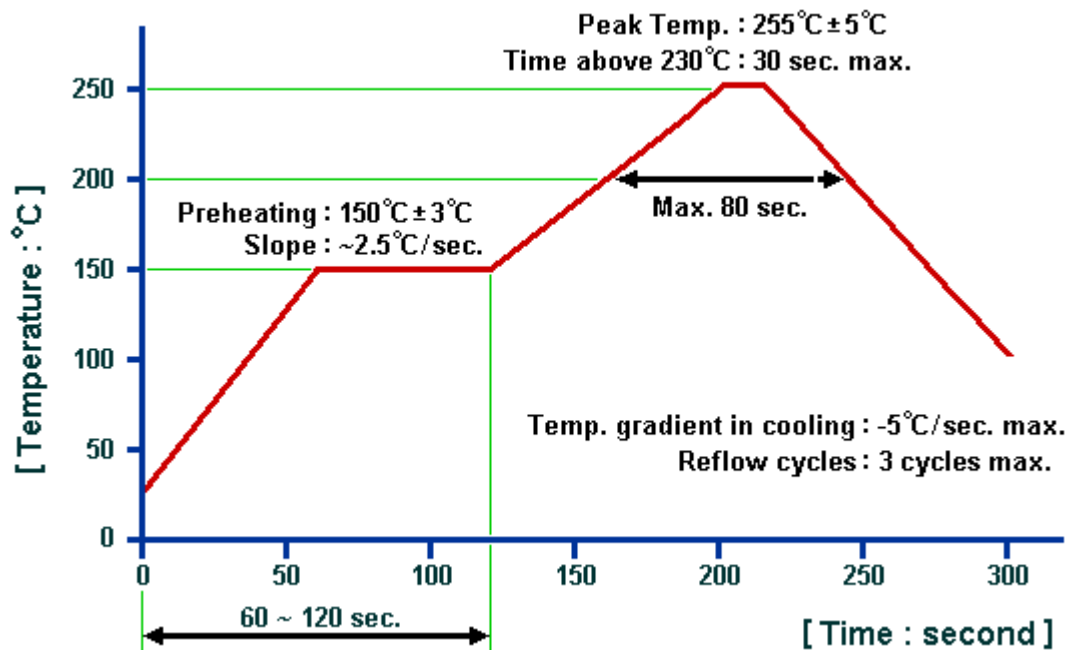

© ACT2019. All Rights Reserved.

1. The specifications of this device are subject to change or obsolescence without notice.
2. Typically, equipment utilizing this device requires emissions testing and government approval, which is the responsibility of the equipment manufacturer.
3. Our liability is only assumed for the Surface Acoustic Wave (SAW) component(s) per se, not for applications, processes and circuits implemented within components or assemblies.